



## About Warning

 **WARNING:** A WARNING indicates a potential for property damage, personal injury, or death.

# Dell™ Latitude™ E6400

## Setup and Features Information

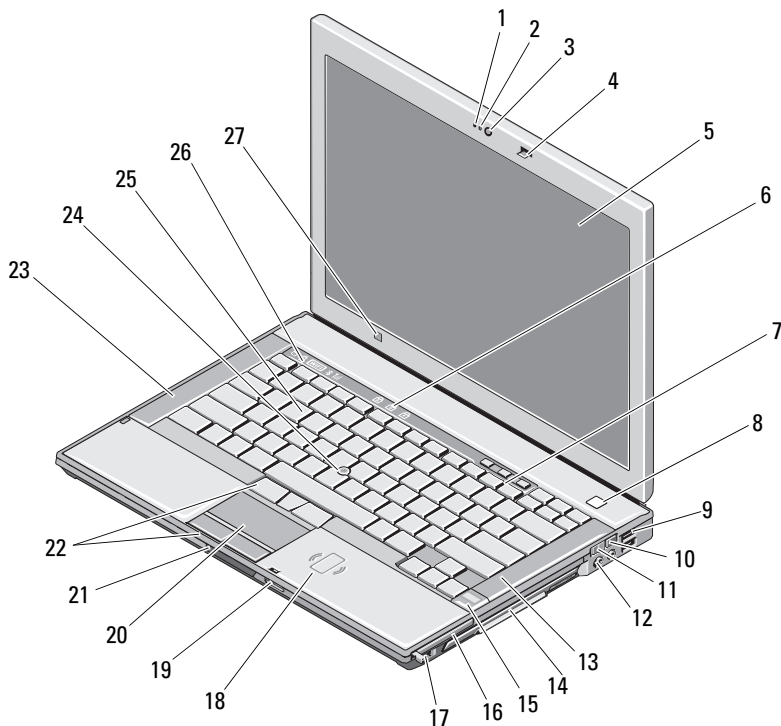

- |   |                       |   |                         |
|---|-----------------------|---|-------------------------|
| 1 | microphone (optional) | 2 | camera light (optional) |
| 3 | camera (optional)     | 4 | display latch           |
| 5 | display               | 6 | keyboard status lights  |

September 2008



ONU031A02

- |    |  |    |                                       |
|----|--|----|---------------------------------------|
| 7  | volume control buttons                 | 8  | power button                          |
| 9  | USB connectors (2)                     | 10 | Wi-Fi Catcher™ Network Locator        |
| 11 | wireless switch                        | 12 | audio connectors (2)                  |
| 13 | right speaker                          | 14 | media bay (with optical drive)        |
| 15 | fingerprint reader (optional)          | 16 | PC Card slot                          |
| 17 | IEEE 1394a connector                   | 18 | contactless smart-card reader         |
| 19 | Secure Digital (SD) memory-card reader | 20 | touch pad                             |
| 21 | display latch release                  | 22 | touch pad buttons/track stick buttons |
| 23 | left speaker                           | 24 | track stick                           |
| 25 | keyboard                               | 26 | device status lights                  |
| 27 | ambient light sensor                   |    |                                       |

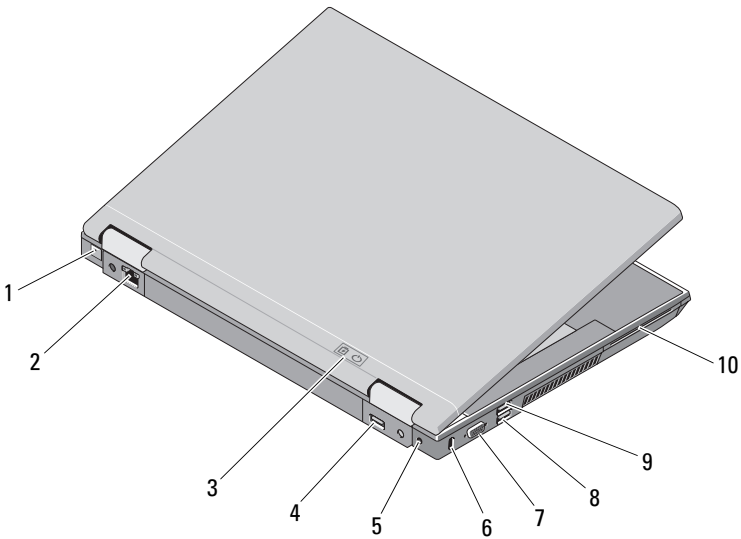

- |   |                                  |   |                         |
|---|----------------------------------|---|-------------------------|
| 1 | RJ-11 modem connector (optional) | 2 | RJ-45 network connector |
| 3 | battery light/power light        | 4 | multimode DisplayPort   |
| 5 | AC adapter                       | 6 | security cable slot     |

7 video connector

8 eSATA/USB connector

9 USB PowerShare connector

10 smart card reader

 **WARNING:** Do not block, push objects into, or allow dust to accumulate in the air vents. Do not store your Dell™ computer in a low-airflow environment, such as a closed briefcase, while it is running. Restricting the airflow can damage the computer or cause a fire. The computer turns on the fan when the computer gets hot. Fan noise is normal and does not indicate a problem with the fan or the computer.

## Quick Setup

 **WARNING:** Before you begin any of the procedures in this section, read the safety information that shipped with your computer. For additional best practices information, see [www.dell.com/regulatory\\_compliance](http://www.dell.com/regulatory_compliance).

 **WARNING:** The AC adapter works with electrical outlets worldwide. However, power connectors and power strips vary among countries. Using an incompatible cable or improperly connecting the cable to the power strip or electrical outlet may cause fire or equipment damage.

 **CAUTION:** When you disconnect the AC adapter cable from the computer, grasp the connector, not the cable itself, and pull firmly but gently to avoid damaging the cable. When you wrap the AC adapter cable, ensure that you follow the angle of the connector on the AC adapter to avoid damaging the cable.

 **NOTE:** Some devices may not be included if you did not order them.

 **NOTE:** It is recommended that you turn on and shut down your computer at least once before you install any cards or connect the computer to a docking device or other external device, such as a printer.

- 1 Connect the AC adapter to the AC adapter connector on the computer and to the electrical outlet.

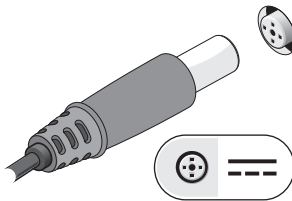

- 2** Connect the network cable.

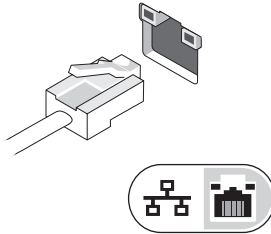

- 3** Connect USB devices, such as a mouse or keyboard.

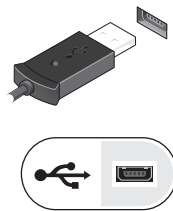

- 4** Connect IEEE 1394 devices, such as a DVD player.

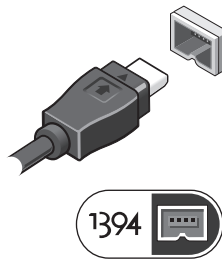

- 5 Open the computer display and press the power button to turn on the computer.



## Specifications



**NOTE:** Offerings may vary by region. For more information regarding the configuration of your computer, click **Start**→ **Help and Support** and select the option to view information about your computer.

---

### Video

---

**NOTE:** Your Dell™ computer has both integrated and discrete video options.

Video type:	integrated and discrete on system board, hardware accelerated
Data bus	integrated video or PCI-Express video x16
Video controller	integrated video: Intel® GMA 4500 MHD discrete video: nVIDIA Quadro NVS 160M
Video memory	integrated video: up to 1 GB (with 2 GB or more system memory—Microsoft® Windows® XP) up to 1.7 GB (with 4 GB or more system memory—Windows Vista®) discrete video: 256 MB dedicated memory

---

**Battery**

---

Type	12-cell "smart" lithium ion prismatic slice (84 Whr) 9-cell "smart" lithium ion (85 Whr) 6-cell "smart" lithium ion (56 Whr) 4-cell "smart" lithium ion (35 Whr)
------	---

## Dimensions:

## 4-cell and 6-cell lithium-ion batteries:

Depth	206 mm (8.11 inches)
Height	19.8 mm (0.78 inch)

## 9-cell lithium-ion batteries:

Depth	208 mm (8.67 inches)
Height	22.3 mm (0.88 inch)

## 12-cell lithium-ion slice batteries:

Depth	14.48 mm
Height	217.24 mm
Weight	0.24 kg (0.53 lb) (4 cell) 0.33 kg (0.73 lb) (6 cell) 0.51 kg (1.12 lb) (9 cell) 0.85 kg (1.87 lb) 12 cell slice

## Voltage:

4-cell battery	14.8 VDC
6-cell and 9-cell	11.1 VDC
12-cell slice battery	14.8 VDC

## Temperature range:

Operating	0° to 40°C (32° to 104°F)
Storage	-10° to 65°C (14° to 149°F)

Coin-cell battery	CR-2032
-------------------	---------

---

**AC Adapter**

---

Input voltage	100–240 VAC
Input current (maximum)	1.5 A
Input frequency	50–60 Hz
Temperature range:	
Operating	0° to 35°C (32° to 95°F)
Storage	–40° to 65°C (–40° to 149°F)

## PA-12 65 W Travel AC adapter:

Output voltage	19.5 V DC
Output current	3.34 A
Height	15 mm (0.6 inches)
Width	66 mm (2.6 inches)
Depth	127 mm (5.0 inches)
Weight	0.29 kg (0.64 lb)

## PA-10 90 W D-Series AC adapter:

Output voltage	19.5 V DC
Output current	4.62 A
Height	32 mm (1.3 inches)
Width	60 mm (2.4 inches)
Depth	140 mm (5.5 inches)
Weight	0.425 kg (0.9 lb)

## PA-3E 90 E-Series AC adapter:

Output voltage	19.5 V DC
Output current	4.62 A
Height	15 mm (0.6 inches)
Width	70 mm (2.8 inches)
Length	147 mm (5.8 inches)
Weight	0.345 kg (0.76 lb)

---

**Information in this document is subject to change without notice.**  
**© 2008 Dell Inc. All rights reserved. Printed in the U.S.A.**

Reproduction of these materials in any manner whatsoever without the written permission of Dell Inc. is strictly forbidden.

Trademarks used in this text: *Dell*, *Latitude*, *Wi-Fi Catcher*, and the *DELL* logo are trademarks of Dell Inc.; *Intel* is a registered trademark of Intel Corporation in the U.S. and other countries; *Microsoft*, *Windows*, and *Windows Vista* are either trademarks or registered trademarks of Microsoft Corporation in the United States and/or other countries.

Other trademarks and trade names may be used in this document to refer to either the entities claiming the marks and names or their products. Dell Inc. disclaims any proprietary interest in trademarks and trade names other than its own.